

Cylinders and mountings conform to ISO 15552

Complete functional unit with LED display

Central electrical connector, polarity-safe

Integrated 5/2 or 5/3 valve

Additional output ports (2 & 4)

Integrated flow regulator for speed control

Integrated reed or electronically switches

Protection class IP67, suitable for food and beverage sector

Energy efficient

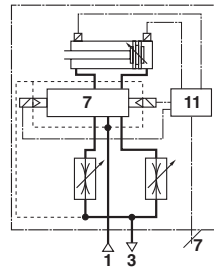

Technical features

Medium:

Compressed air, filtered, lubricated or non-lubricated
 Particles size: Class 7, ISO 8573 – 1 (dated 2001)
 Humidity and water content: Air supply must be dry.
 Corresponding of the application and working conditions the air must be dry enough to avoid condensate. The pressure dewpoint must be minimum 15° under the application and working conditions. Oil: Class 4, ISO 8573 – 1 (dated 2001)

Standard:

Based on ISO 15552 (length, mounting pitch and thread dimensions according to ISO 15552. Some outside dimensions different to ISO 15552)

Operation:

Double acting, magnetic piston, adjustable cushioning

Operating pressure:

2 ... 8 bar

Port size:

G1/8, G1/4, G3/8

Cylinder diameters:

32, 40, 50, 63, 80, 100 mm

Standard strokes:

See below

Non-standard strokes:

Available (25 ... 1000 mm)

Operating temperature:

-5 ... +50°C max.

Supply voltage:

24 V d.c.

Multipole connection:

M12 x 1 male, 8 pin

Power consumption:

1 W max

Rating:

100 % E.D.

Protection class:

IP 67

Materials:

Profile barrel: anodised aluminium,
 End covers: pressure diecast anodised aluminium
 Piston rod: stainless steel, see page 2
 Piston rod seals: polyurethane
 Piston seals: polyurethane
 O-rings: nitrile rubber

Technical data

Cylinder Ø (mm)	32	40	50	63	80	100
Air ports	G 1/8	G 1/8	G 1/8	G 1/4	G 1/4	G 3/8
Piston rod Ø (mm)	12	16	20	20	25	25
Piston rod thread	M10 x 1,25	M12 x 1,25	M16 x 1,5	M16 x 1,5	M20 x 1,5	M20 x 1,5
Cushion length (mm)	19	22	24	24	27	34
Theoretical thrusts at 6 bar outstroke N	482	754	1178	1870	3016	4710
Theoretical thrusts at 6 bar instroke N	414	633	990	1680	2722	4416
Air consumption at 6 bar outstroke l/cm	0,056	0,088	0,137	0,218	0,350	0,550
Air consumption at 6 bar instroke l/cm	0,050	0,076	0,117	0,198	0,324	0,514

Standard strokes

Cylinder Ø (mm)	Strokes (mm)										
	25	50	80	100	125	160	200	250	320	400	500
32	•	•	•	•	•	•	•	•	•	•	•
40	•	•	•	•	•	•	•	•	•	•	•
50	•	•	•	•	•	•	•	•	•	•	•
63	•	•	•	•	•	•	•	•	•	•	•
80	•	•	•	•	•	•	•	•	•	•	•
100	•	•	•	•	•	•	•	•	•	•	•

Reduced Installation Time & Cost

To connect the IVAC you simply run a single ring main to provide an air supply to each unit. There is no mounting of valve islands to the machine framework or inside a cabinet and there is no pipework to run around the machine to connect each valve to each actuator.

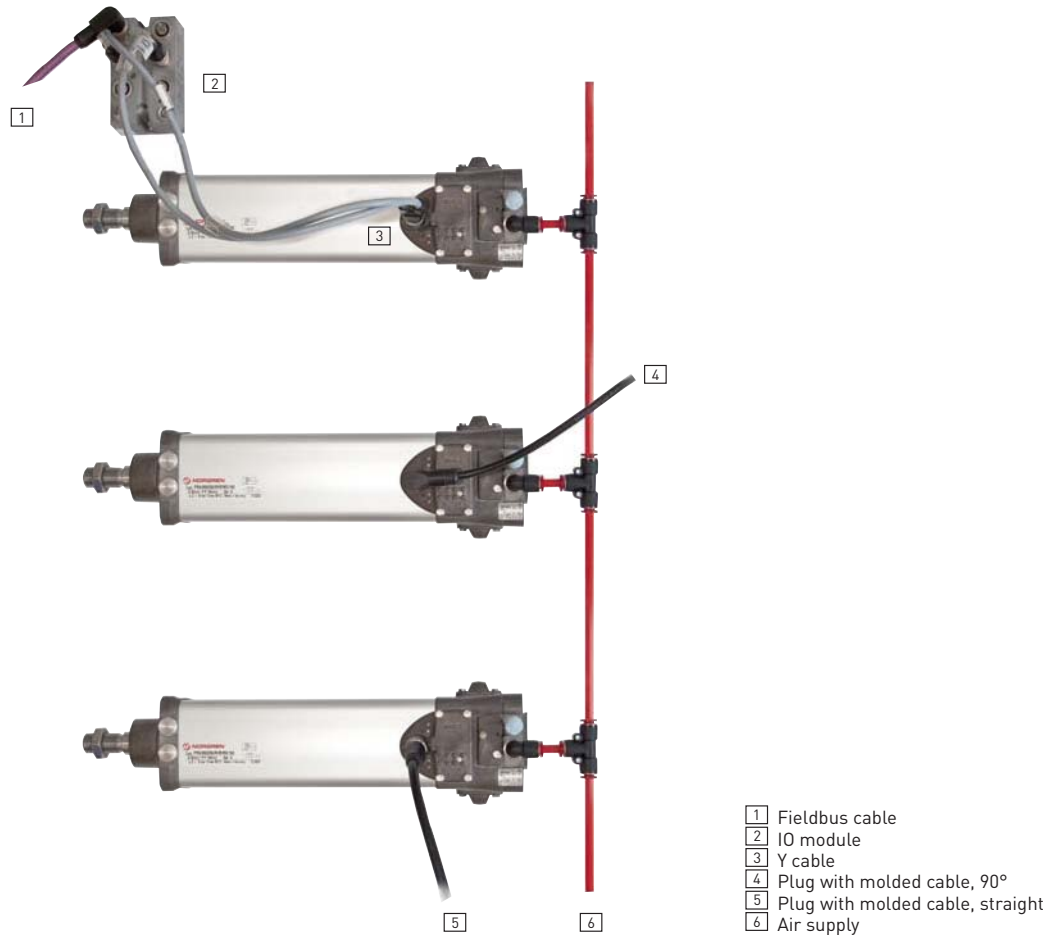



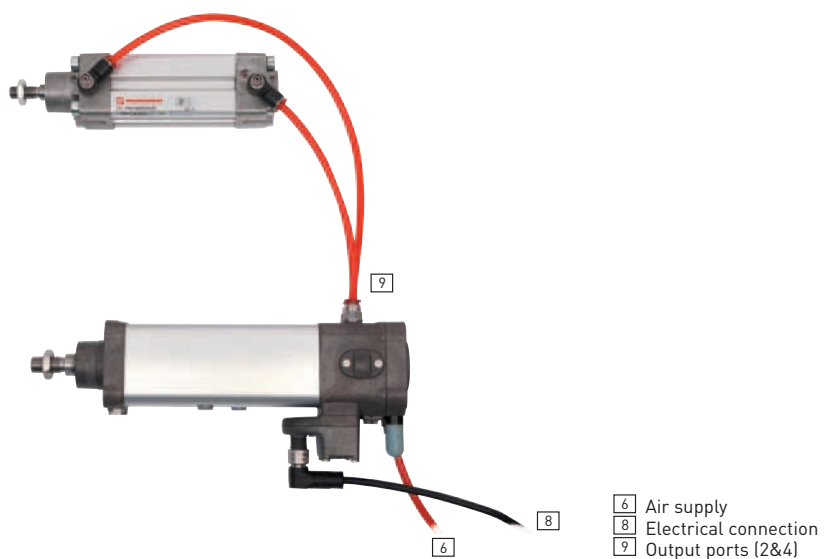

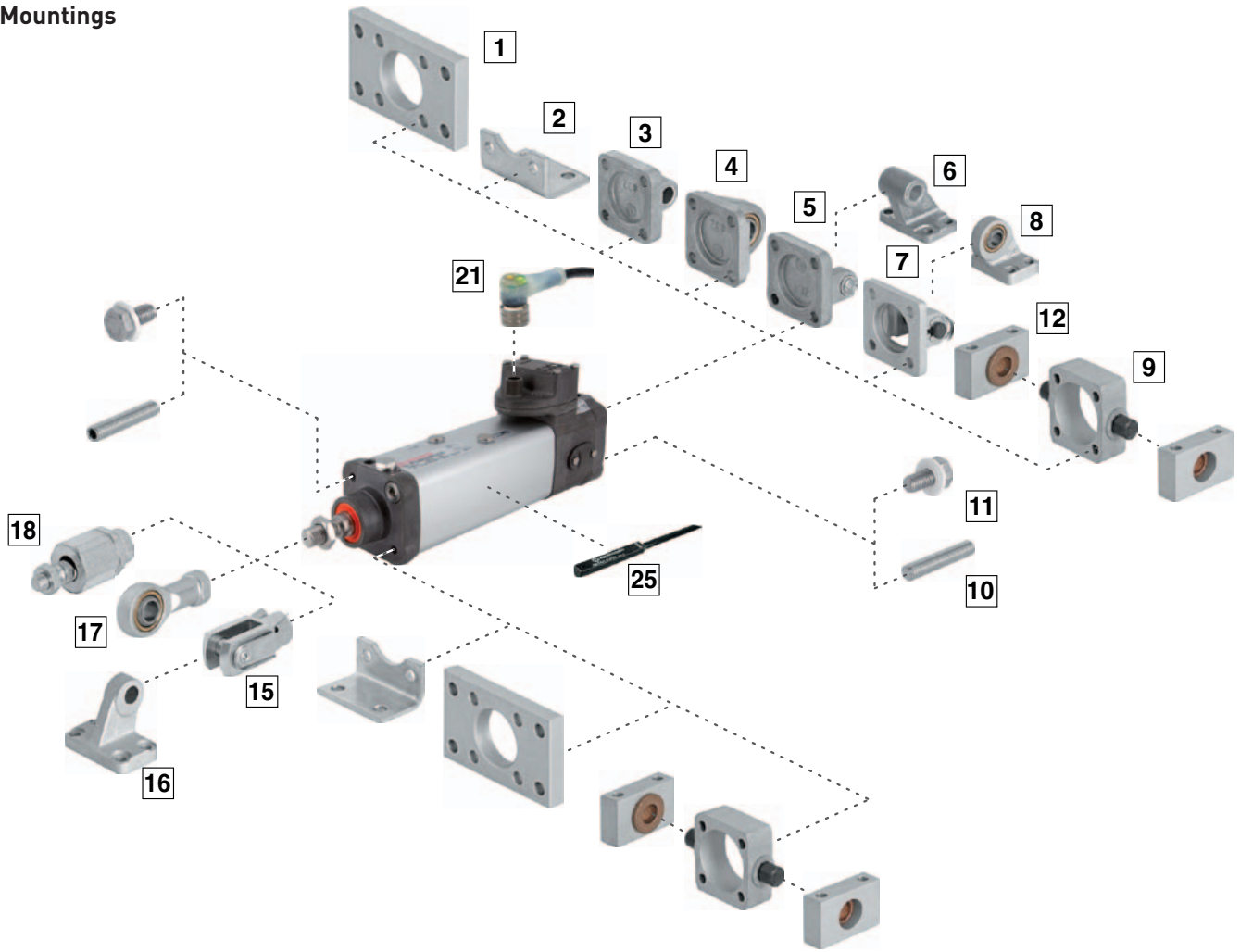











One of the advantages of the IVAC cylinders is to use the output ports (2 & 4) from the main valve to operate an additional cylinder.



Mountings

Position	Style	Standard	Corrosion protected	Stainless steel
1	B, G	Clear anodised aluminium	Clear anodised aluminium. Screws: A2	X 5 Cr Ni 18 10 (1.4301; AISI 304). Screws: A2
2	C	Galvanized steel (ø 32 ... 63 mm) Painted steel (ø 80 & 100 mm)	—	X 5 Cr Ni 18 10 (1.4301; AISI 304). Screws: A2
3	R	Diecast aluminium	Black corrosion protected diecast aluminium. Certified for the food industry. Screws: A2	—
4	UR	Galvanized aluminium Inner ring: steel Outer ring: brass	Black corrosion protected diecast aluminium Certified for the food industry Inner ring: stainless Steel (austenitic) Outer ring: nickel plated hardened steel	—
5	D	Diecast aluminium Bolt: galvanized steel (martensitic) Circlip: galvanized steel	Black corrosion protected diecast aluminium Certified for the food industry Bolt: X 10 Cr Ni S 18 9 (1.4305, AISI 303) Circlip: Stainless steel (martensitic). Screws: A2	X 5 Cr Ni 18 10 (1.4301; AISI 304). Screws: A2 Bolt: X 10 Cr Ni S 18 9 (1.4305; AISI 303)
6	SW	Diecast aluminium	Black corrosion protected diecast aluminium Certified for the food industry	X 6 Cr Ni 18 9 (1.4308; AISI 304)
7	US	Galvanized aluminium. Inner ring: steel Outer ring: brass	—	—
8	D2	Painted cast iron. Bolt: stainless steel (martensitic) Circlip: galvanized steel	—	—
9	FH	Cast iron	—	—
10	A	Galvanized steel	—	—
11	Screw	—	—	X 10 Cr Ni S 18 9 (1.4305, AISI 303)
12	S	Clear anodised aluminium Bearing: brass	—	—
15	F	Galvanized steel Bolt: galvanized steel Circlip: Galvanized steel	Nickel plated steel Circlip: X 10 Cr Ni S 18 9 (1.4305, AISI 303) Bolt: X 10 Cr Ni S 18 9 (1.4305, AISI 303)	X 10 Cr Ni S 18 9 (1.4305; AISI 303) Bolt: X 10 Cr Ni S 18 9 (1.4305; AISI 303) Eyebolt: X 10 Cr Ni S 18 9 (1.4305; AISI 303)
16	SS	Painted cast iron	—	—
17	UF	Galvanized steel. Inner ring: steel Outer ring: brass	Nickel plated steel. Inner ring: stainless steel (austenitic) Outer ring: nickel plated hardened steel.	X 10 Cr Ni S 18 9 (1.4305; AISI 303), Inner ring X 105 Cr Co Mo 18-2 (1.4528), Outer ring X 5 Cr Ni 18 10 (1.4301; AISI 304)
18	AK	Galvanized steel	—	—

Mountings and service kits

Model	A	AK	B, G	C	D	D2	F	FH	R
									
	10	18	1	2	5	7	15	9	3
∅	Page 9	Page 9	Page 9	Page 9	Page 10	Page 10	Page 10	Page 10	Page 11
32	QM/8032/35	QM/8025/38	QA/8032/22	QA/8032/21	QA/8032/23	QA/8032/42	QM/8025/25	QA/8032/34	QA/8032/27
40	QM/8032/35	QM/8040/38	QA/8040/22	QA/8040/21	QA/8040/23	QA/8040/42	QM/8040/25	QA/8040/34	QA/8040/27
50	QM/8050/35	QM/8050/38	QA/8050/22	QA/8050/21	QA/8050/23	QA/8050/42	QM/8050/25	QA/8050/34	QA/8050/27
63	QM/8050/35	QM/8050/38	QA/8063/22	QA/8063/21	QA/8063/23	QA/8063/42	QM/8050/25	QA/8063/34	QA/8063/27
80	QM/8080/35	QM/8080/38	QA/8080/22	QA/8080/21	QA/8080/23	QA/8080/42	QM/8080/25	QA/8080/34	QA/8080/27
100	QM/8080/35	QM/8080/38	QA/8100/22	QA/8100/21	QA/8100/23	QA/8100/42	QM/8080/25	QA/8100/34	QA/8100/27
Corrosion protected									
32	—	—	PVQA/8032/22	—	PVQA/8032/23	—	PVQM/8025/25	—	PVQA/8032/27
40	—	—	PVQA/8040/22	—	PVQA/8040/23	—	PVQM/8040/25	—	PVQA/8040/27
50	—	—	PVQA/8050/22	—	PVQA/8050/23	—	PVQM/8050/25	—	PVQA/8050/27
63	—	—	PVQA/8063/22	—	PVQA/8063/23	—	PVQM/8050/25	—	PVQA/8063/27
80	—	—	PVQA/8080/22	—	PVQA/8080/23	—	PVQM/8080/25	—	PVQA/8080/27
100	—	—	PVQA/8100/22	—	PVQA/8100/23	—	PVQM/8080/25	—	PVQA/8100/27
Stainless steel									
32	—	—	KQA/8032/22	KQA/8032/21	KQA/8032/23	—	KQM/55433/25	—	—
40	—	—	KQA/8040/22	KQA/8040/21	KQA/8040/23	—	KQM/55441/25	—	—
50	—	—	KQA/8050/22	KQA/8050/21	KQA/8050/23	—	KQM/55451/25	—	—
63	—	—	KQA/8063/22	KQA/8063/21	KQA/8063/23	—	KQM/55451/25	—	—
80	—	—	KQA/8080/22	KQA/8080/21	KQA/8080/23	—	KQA/8080/25	—	—
100	—	—	KQA/8100/22	KQA/8100/21	KQA/8100/23	—	KQA/8080/25	—	—
Model	S	SS	SW	UF	UR	US	Cover screws	Service kit	
									
	12	16	6	17	4	8	11		
∅	Page 11	Page 12	Page 11	Page 11	Page 12	Page 12	Page 12		
32	QA/8032/41	M/P19931	M/P19493	QM/8025/32	QA/8032/33	M/P40310	—	PRQA/882032/00	
40	QA/8040/41	M/P19932	M/P19494	QM/8040/32	QA/8040/33	M/P40311	—	PRQA/882040/00	
50	QA/8040/41	M/P19933	M/P19495	QM/8050/32	QA/8050/33	M/P40312	—	PRQA/882050/00	
63	QA/8063/41	M/P19934	M/P19496	QM/8050/32	QA/8063/33	M/P40313	—	PRQA/882063/00	
80	QA/8063/41	M/P19935	M/P19497	QM/8080/32	QA/8080/33	M/P40314	—	PRQA/882080/00	
100	QA/8100/41	M/P19936	M/P19498	QM/8080/32	QA/8100/33	M/P40315	—	PRQA/882100/00	
Corrosion protected									
32	—	—	M/P40459	PVQM/8025/32	PVQA/8032/33	—	—	—	
40	—	—	M/P40460	PVQM/8040/32	PVQA/8040/33	—	—	—	
50	—	—	M/P40461	PVQM/8050/32	PVQA/8050/33	—	—	—	
63	—	—	M/P40462	PVQM/8050/32	PVQA/8063/33	—	—	—	
80	—	—	M/P40463	PVQM/8080/32	PVQA/8080/33	—	—	—	
100	—	—	M/P40464	PVQM/8080/32	PVQA/8100/33	—	—	—	
Stainless steel									
32	—	—	M/P72288	KQM/8032/32	—	—	PVQA/882032/88	—	
40	—	—	M/P72289	KQM/8040/32	—	—	PVQA/882032/88	—	
50	—	—	M/P72290	KQM/8050/32	—	—	PVQA/882050/88	—	
63	—	—	M/P72291	KQM/8050/32	—	—	PVQA/882050/88	—	
80	—	—	M/P72292	KQM/8080/32	—	—	PVQA/882080/88	—	
100	—	—	M/P72293	KQM/8080/32	—	—	PVQA/882080/88	—	

Magnetically operated switches with LED

Model Reed	Electronic	Voltage *2)		Current max. (mA)	Temperature (°C)	Features	Cable length (m)	Cable type	Data sheet
		(V a.c.)	(V d.c.)						
M/50/LSU/ZV	-	10 ... 240	10 ... 170	180	-20 ... +80	-	2	PVC 2 x 0,25	N/en 4.3.005
-	M/50/EAP/ZV	-	10 ... 30	150	-40 ... +80	PNP	2	PVC 3 x 0,25	N/en 4.3.007

*2) Supply voltage 24 V d.c. (± 10%) max for P.A/88200/M only.

M12 cables

Cable length	Plug with moulded cable IP 67	Y-cable, M12 female 8 pin, 2 x M12 male 4 pin IP67
(m)		
2	M/P74581/2 (straight)	M/P74589 (0,45 m)
5	M/P74581/5 (straight)	
10	M/P74581/10 (straight)	
2	M/P74582/2 (90°)	
5	M/P74582/5 (90°)	
10	M/P74582/10 (90°)	

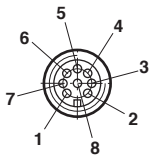
Wiring diagram for M12 male connector

Valves	Wiring diagram for connector cable M/P74581/, M/P74582/.
Pin 1	Not used White
Pin 2	Solenoid 2 (instroke) Brown
Pin 3	0 V Green
Pin 4	Solenoid 1 (outstroke) Yellow

Switches	Wiring diagram for connector cable M/P74581/, M/P74582/.
Pin 5	+ 24 V d.c. Grey
Pin 6	Switch 2 (rear end cover) Pink
Pin 7	0 V Blue
Pin 8	Switch 1 (front end cover) Red

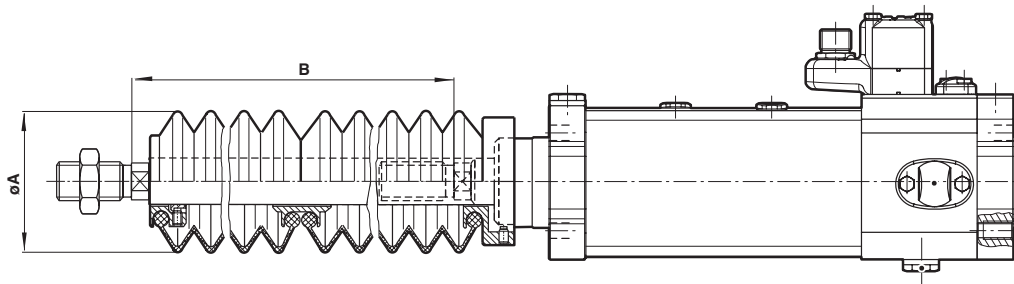
P.A/882000/MG./M./.; Cylinder with piston rod bellow

Ø	Ø A	Stroke max	Piston rod extention B		Model
			per bellow	for first bellow	
32	40	60	30	25	P#A/882032/MG+/M./*
40	63	145	50	32	P#A/882040/MG+/M./*
50	63	145	40	32	P#A/882050/MG+/M./*
63	63	145	40	32	P#A/882063/MG+/M./*
80	80	250	50	45	P#A/882080/MG+/M./*
100	80	250	50	45	P#A/882100/MG+/M./*

* Standard stroke length

Piston rod material

+ Valve function

. Magnetically switch

Mountings

Front or rear stud mounting A

Conforms to ISO 15552, type MX1

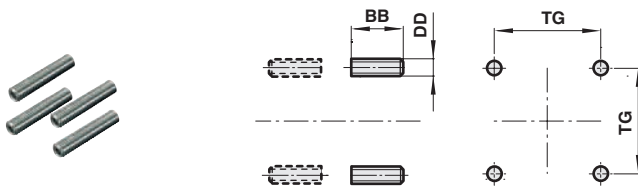

Standard

∅	BB	DD	TG	kg	Model (A)
32/40	17	M6	32,5/38	0,02	QM/8032/35
50/63	23	M8	46,5/56,5	0,05	QM/8050/35
80/100	28	M10	72/89	0,08	QM/8080/35

Front flange B, G

Conforms to ISO 15552, type MF1 and MF2

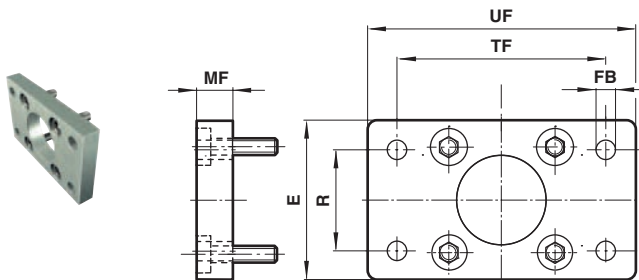

Standard

∅	E	∅ FB	MF	R	TF	UF	kg	Model (B, G)
32	50	7	10	32	64	80	0,25	QA/8032/22
40	55	9	10	36	72	90	0,35	QA/8040/22
50	65	9	12	45	90	110	0,70	QA/8050/22
63	75	9	12	50	100	125	0,80	QA/8063/22
80	100	12	16	63	126	154	1,35	QA/8080/22
100	120	14	16	75	150	186	2,20	QA/8100/22

Corrosion protected version

32	50	7	10	32	64	80	0,25	PVQA/8032/22
40	55	9	10	36	72	90	0,35	PVQA/8040/22
50	65	9	12	45	90	110	0,7	PVQA/8050/22
63	75	9	12	50	100	125	0,8	PVQA/8063/22
80	100	12	16	63	126	154	1,35	PVQA/8080/22
100	120	14	16	75	150	186	2,20	PVQA/8100/22

Stainless steel

32	50	7	10	32	64	80	0,26	KQA/8032/22
40	55	9	10	36	72	90	0,31	KQA/8040/22
50	65	9	12	45	90	110	0,56	KQA/8050/22
63	75	9	12	50	100	125	0,73	KQA/8063/22
80	100	12	16	63	126	154	1,73	KQA/8080/22
100	120	14	16	75	150	186	2,51	KQA/8100/22

Piston rod swivel AK

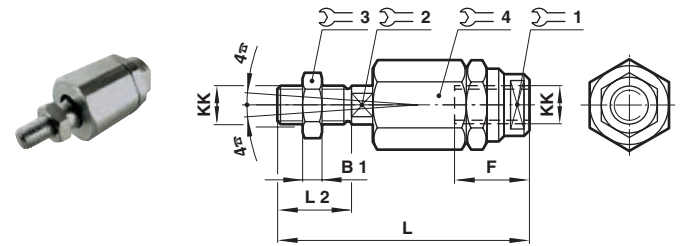

Standard

∅	KK	B1	F	L	L2	1	2	3	4	kg	Model (AK)
32	M10x1,25	5	26	73	20	19	12	17	30	0,20	QM/8025/38
40	M12x1,25	6	26	77	24	19	12	19	30	0,20	QM/8040/38
50/63	M16x1,5	8	34	106	32	30	19	24	42	0,65	QM/8050/38
80/100	M20x1,5	10	42	122	40	30	19	30	42	0,72	QM/8080/38

Foot mounting C

Conforms to ISO 15552, type MS1

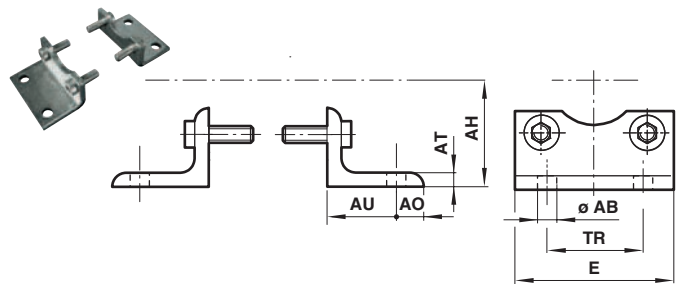

Standard

∅	∅ AB	AH	AO	AT	AU	E	TR	kg	Model (C)
32	7	32	8	4	24	48	32	0,15	QA/8032/21
40	10	36	9	4	28	53	36	0,18	QA/8040/21
50	10	45	10	5	32	64	45	0,30	QA/8050/21
63	10	50	12	5	32	74	50	0,39	QA/8063/21
80	12	63	19	5	41	98	63	0,80	QA/8080/21
100	14	71	19	5	41	115	75	0,95	QA/8100/21

Stainless steel

32	7	32	11	4	24	48	32	0,16	KQA/8032/21
40	9	36	12	5	28	53	36	0,19	KQA/8040/21
50	9	45	13	5	32	64	45	0,32	KQA/8050/21
63	9	50	13	5	32	74	50	0,41	KQA/8063/21
80	12	63	19	6	41	98	63	0,83	KQA/8080/21
100	14	71	19	6	41	115	75	0,98	KQA/8100/21

Rear clevis D

Conforms to ISO 15552, type MP2

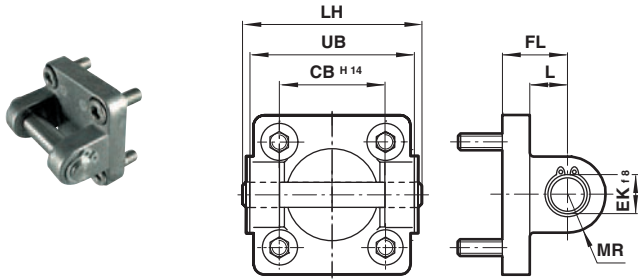
Standard

∅	CB ^{H14}	∅ EK ^{h9}	FL	L	LH	MR	UB	kg	Model (D)
32	26	10	22	13	52	9	45	0,11	QA/8032/23
40	28	12	25	16	60	12	52	0,16	QA/8040/23
50	32	12	27	17	68	12	60	0,22	QA/8050/23
63	40	16	32	22	79	15	70	0,34	QA/8063/23
80	50	16	36	22	99	15	90	0,54	QA/8080/23
100	60	20	41	27	119	20	110	0,90	QA/8100/23

Corrosion protected version

32	26	10	22	13	52	9	45	0,11	PVQA/8032/23
40	28	12	25	16	60	12	52	0,16	PVQA/8040/23
50	32	12	27	17	68	12	60	0,22	PVQA/8050/23
63	40	16	32	22	79	15	70	0,34	PVQA/8063/23
80	50	16	36	22	99	15	90	0,54	PVQA/8080/23
100	60	20	41	27	119	20	110	0,90	PVQA/8100/23

Stainless steel

32	26	10	22	13	52	9	45	0,11	KQA/8032/23
40	28	12	25	16	60	12	52	0,16	KQA/8040/23
50	32	12	27	17	68	12	60	0,22	KQA/8050/23
63	40	16	32	22	79	15	70	0,34	KQA/8063/23
80	50	16	36	22	99	15	90	0,54	KQA/8080/23
100	60	20	41	27	119	20	110	0,9	KQA/8100/23

Front or rear detachable trunnion FH

Conforms to VDMA 24562 part 2, type MT 5/6

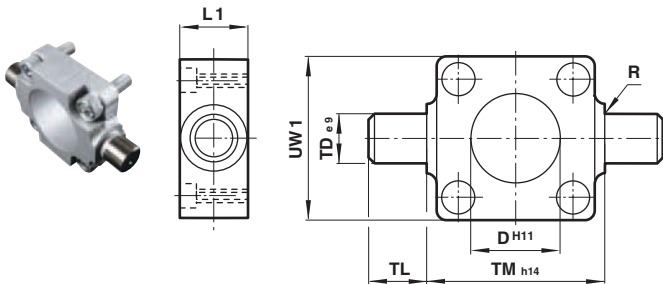
Standard

∅	∅ Dh11	L1	R	∅ TD ^{e9}	TL	TM ^{h14}	UW1	kg	Model (FH)
32	30	16	1	12	12	50	45	0,20	QA/8032/34
40	35	20	1,6	16	16	63	55	0,38	QA/8040/34
50	40	24	1,6	16	16	75	65	0,60	QA/8050/34
63	45	24	1,6	20	20	90	75	1,10	QA/8063/34
80	45	28	1,6	20	20	110	100	1,90	QA/8080/34
100	55	38	2	25	25	132	120	3,50	QA/8100/34

Rear clevis D2

Conforms to ISO 15552, type AB6

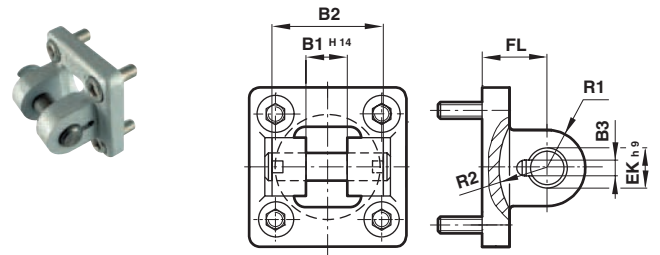
Standard

∅	B1 ^{H14}	B2	B3	∅ EK ^{h9}	FL	R1	R2	kg	Model (D2)
32	14	34	3,3	10	22	11	17	0,20	QA/8032/42
40	16	40	4,3	12	25	12	20	0,23	QA/8040/42
50	21	45	4,3	16	27	14,5	22	0,36	QA/8050/42
63	21	51	4,3	16	32	18	25	0,55	QA/8063/42
80	25	65	4,3	20	36	22	30	0,90	QA/8080/42
100	25	75	4,3	20	41	22	32	1,45	QA/8100/42

Piston rod clevis F

Conforms to DIN ISO 8140

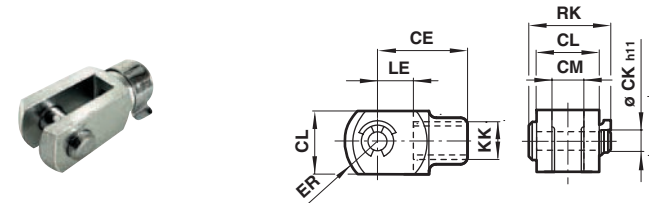
Standard

∅	KK	CE	∅ CK ^{h11}	CL	CM	ER	LE	RK	kg	Model (F)
32	M10x1,25	40	10	20	10	16	20	28	0,09	QM/8025/25
40	M12x1,25	48	12	24	12	19	24	32	0,13	QM/8040/25
50/63	M16x1,5	64	16	32	16	25	32	41,5	0,33	QM/8050/25
80/100	M20x1,5	80	20	40	20	32	40	50	0,67	QM/8080/25

Corrosion protected version

32	M10x1,25	40	10	20	10	16	20	28	0,09	PVQM/8032/25
40	M12x1,25	48	12	24	12	19	24	32	0,13	PVQM/8040/25
50/63	M16x1,5	64	16	32	16	25	32	41,5	0,33	PVQM/8050/25
80/100	M20x1,5	80	20	40	20	32	40	50	0,67	PVQM/8080/25

Stainless steel

32	M10x1,25	40	10	20	10	16	20	28	0,09	KQM/55433/25
40	M12x1,25	48	12	24	12	19	24	32	0,13	KQM/55441/25
50/63	M16x1,5	64	16	32	16	25	32	41,5	0,33	KQM/55451/25
80/100	M20x1,5	80	20	40	20	32	40	50	0,67	KQM/8080/25

Rear eye R

Conforms to ISO 15552, type MP4

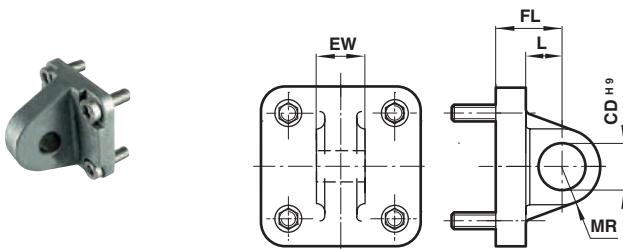
Standard

∅	∅ CD ^{H9}	EW	FL	L	MR	kg	Model (R)
32	10	25,8	22	13	9	0,09	QA/8032/27
40	12	27,8	25	16	12	0,11	QA/8040/27
50	12	31,7	27	17	12	0,17	QA/8050/27
63	16	39,7	32	22	15	0,24	QA/8063/27
80	16	49,7	36	22	15	0,37	QA/8080/27
100	20	59,7	41	27	20	0,59	QA/8100/27
Corrosion protected version							
32	10	25,8	22	13	9	0,09	PVQA/8032/27
40	12	27,8	25	16	12	0,11	PVQA/8040/27
50	12	31,7	27	17	12	0,17	PVQA/8050/27
63	16	39,7	32	22	15	0,24	PVQA/8063/27
80	16	49,7	36	22	15	0,37	PVQA/8080/27
100	20	59,7	41	27	20	0,59	PVQA/8100/27

Universal piston rod eye UF

Conforms to DIN ISO 8139

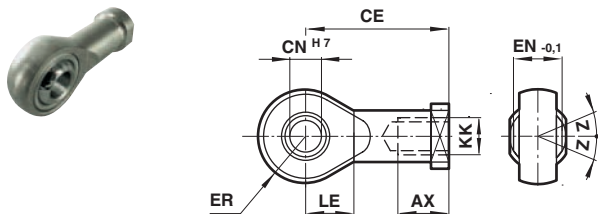
Standard

∅	Thread KK	AX	CE	∅ CN ^{H7}	EN ^{-0,1}	ER	LE	Z	kg	Model (UF)
32	M10x1,25	20	43	10	14	14	15	13°	0,09	QM/8025/32
40	M12x1,25	22	50	12	16	16	17	13°	0,13	QM/8040/32
50/63	M16x1,5	28	64	16	21	21	22	15°	0,33	QM/8050/32
80/100	M20x1,5	33	77	20	25	25	26	15°	0,67	QM/8080/32
Corrosion protected version										
32	M10x1,25	20	43	10	14	14	15	13°	0,09	PVQM/8025/32
40	M12x1,25	22	50	12	16	16	17	13°	0,13	PVQM/8040/32
50/63	M16x1,5	28	64	16	21	21	22	15°	0,33	PVQM/8050/32
80/100	M20x1,5	33	77	20	25	25	26	15°	0,40	PVQM/8080/32
Stainless steel										
32	M10x1,25	20	43	10	14	14,5	14	13°	0,07	KQM/8032/32
40	M12x1,25	22	50	12	16	16,5	16	13°	0,11	KQM/8040/32
50/63	M16x1,5	28	64	16	21	21,5	21	15°	0,21	KQM/8050/32
80/100	M20x1,5	33	77	20	25	25,5	25	15°	0,38	KQM/8080/32

Trunnion support S

Conforms to ISO 15552, type AT4

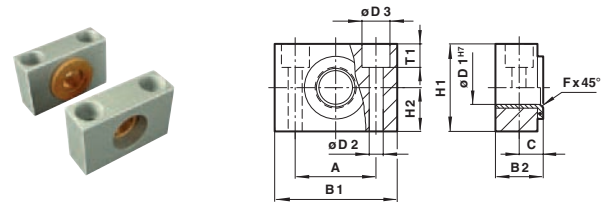
Standard

∅	A	B1	B2	C	∅ D1 ^{H7}	∅ D1	∅ D3	Fx 45°	H1	H2	T1	kg	Model (S)
32	32	46	18	10,5	12	6,6	11	1	30	15	6,8	0,10	QA/8032/41
40/50	36	55	21	12	16	9	15	1,6	36	18	9	0,14	QA/8040/41
63/80	42	65	23	13	20	11	18	1,6	40	20	11	0,18	QA/8063/41
100	50	75	28,5	16	25	14	20	2	50	25	13	0,34	QA/8100/41

Wide hinge SW

Conforms to ISO 15552, type AB7

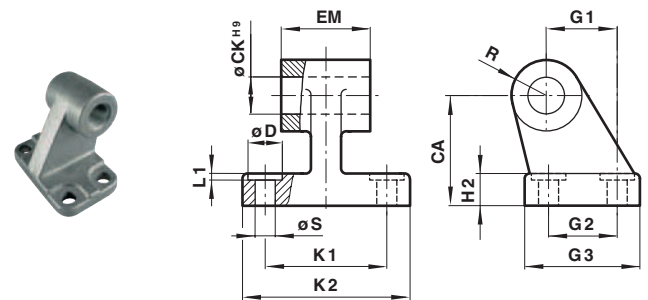
Standard

∅	CA	∅ CK ^{H9}	∅ D	H2	EM	G1	G2	G3	K1	K2	L1	R	∅ S	kg	Model (SW)
32	32	10	11	7	25,5	21	18	31	38	50	1,6	10	6,6	0,05	M/P19493
40	36	12	11	9	27,5	24	22	35	41	54	1,6	11	6,6	0,07	M/P19494
50	45	12	15	11	31,5	33	30	45	50	65	1,6	13	9	0,14	M/P19495
63	50	16	15	12	39,5	37	35	50	52	67	1,6	15	9	0,18	M/P19496
80	63	16	18	14	49,5	47	40	60	66	84	2,5	15	11	0,28	M/P19497
100	71	20	18	15	59,5	55	50	70	76	94	2,5	19	11	0,42	M/P19498
Corrosion protected version															
32	32	10	11	8	26,5	21	18	31	38	51	1,6	10	6,6	0,05	M/P40459
40	36	12	11	10	28,5	24	22	35	41	54	1,6	11	6,6	0,07	M/P40460
50	45	12	15	12	32,5	33	30	45	50	65	1,6	13	9	0,14	M/P40461
63	50	16	15	12	40,5	37	35	50	52	67	1,6	15	9	0,18	M/P40462
80	63	16	18	14	50,5	47	40	60	66	86	2,5	15	11	0,28	M/P40463
100	71	20	18	15	60,5	55	50	70	76	96	2,5	19	11	0,42	M/P40464
Stainless steel															
32	32	10	11	8	26	21	18	31	38	51	1,6	10	6,6	0,15	M/P72288
40	36	12	11	10	28	24	22	35	41	53	1,6	11	6,6	0,21	M/P72289
50	45	12	15	12	32	33	30	45	50	65	1,6	13	9	0,41	M/P72290
63	50	16	15	12	40	37	35	50	52	67	1,6	15	9	0,53	M/P72291
80	63	16	18	14	50	47	40	60	66	86	2,5	15	11	0,82	M/P72292
100	71	20	18	15	60	55	50	70	76	96	2,5	19	11	1,22	M/P72293

Universal rear eye UR

Conforms to ISO 15552, type MP6

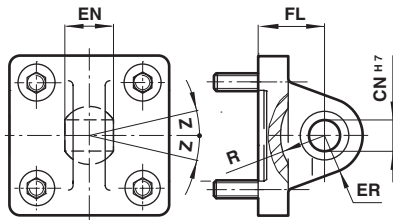
Standard

∅	∅ CN ^{H7}	EN	ER	FL	R	Z	kg	Model (UR)
32	10	14	16	22	14,5	13°	0,15	QA/8032/33
40	12	16	18	25	18	13°	0,25	QA/8040/33
50	16	21	21	27	19	15°	0,40	QA/8050/33
63	16	21	23	32	24	15°	0,55	QA/8063/33
80	20	25	28	36	24	15°	0,90	QA/8080/33
100	20	25	30	41	29	15°	1,50	QA/8100/33
Corrosion protected version								
32	10	14	16	22	14,5	13°	0,15	PVQA/8032/33
40	12	16	19	25	18	13°	0,25	PVQA/8040/33
50	16	21	21	27	19	13°	0,4	PVQA/8050/33
63	16	21	24	32	24	15°	0,55	PVQA/8063/33
80	20	25	28	36	24	15°	0,9	PVQA/8080/33
100	20	25	30	41	29	15°	1,5	PVQA/8100/33

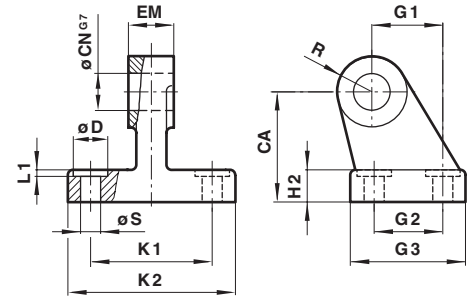
Narrow hinge SS

Standard

∅	CA	∅ CN ^{G7}	∅ D	H2	EM	G1	G2	G3	K1	K2	L1	R	∅ S	kg	Model (SS)
32	32	10	11	8	10	21	18	31	38	51	1,6	10	6,6	0,15	M/P19931
40	36	12	11	10	12	24	22	35	41	54	1,6	11	6,6	0,20	M/P19932
50	45	16	15	12	16	33	30	45	50	65	1,6	13	9	0,48	M/P19933
63	50	16	15	12	16	37	35	50	52	67	1,6	15	9	0,50	M/P19934
80	63	20	18	14	20	47	40	60	66	86	2,5	15	11	0,75	M/P19935
100	71	20	18	15	20	55	50	70	76	96	2,5	19	11	1,20	M/P19936

Swivel hinge US

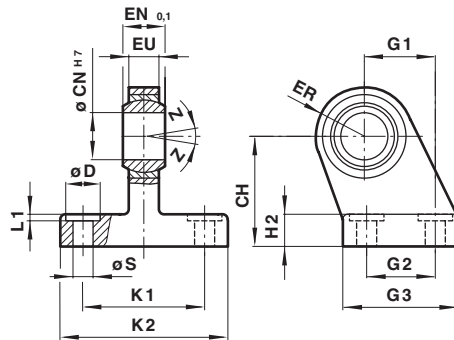
Conforms to VDMA 24562 part 2

Standard

∅	CH	∅ CN ^{H7}	∅ D	EN ^{-0,1}	ER	EU	G1	G2	G3	H2	K1	K2	L1	∅ S	Z	kg	Model (US)
32	32	10	11	14	16	10,5	21	18	31	10	38	51	1,6	6,6	13°	0,19	M/P40310
40	36	12	11	16	18	12	24	22	35	10	41	54	1,6	6,6	13°	0,24	M/P40311
50	45	16	15	21	21	15	33	30	45	12	50	65	1,6	9	13°	0,46	M/P40312
63	50	16	15	21	23	15	37	35	50	12	52	67	1,6	9	15°	0,59	M/P40313
80	63	20	18	25	28	18	47	40	60	14	66	86	2,5	11	15°	1,03	M/P40314
100	71	20	18	25	30	18	55	50	70	15	76	96	2,5	11	15°	1,40	M/P40315

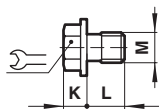
Cover screw (stainless steel)

∅	M	⌀	K	L	kg	Model
32/40	M6	10	5,5	10,5	0,018	PVQA/882032/88
50/63	M8	13	6,8	10,5	0,041	PVQA/882050/88
80/100	M10	17	8,4	10	0,072	PVQA/882080/88

Warning

These products are intended for use in industrial compressed air systems only. Do not use these products where pressures and temperatures can exceed those listed under »**Technical features**«.

Before using these products with fluids other than those specified, for non-industrial applications, life-support systems, or other applications not within published specifications, consult NORGREN.

Through misuse, age, or malfunction, components used in fluid power systems can fail in various modes.

The system designer is warned to consider the failure modes of all component parts used in fluid power systems and to provide adequate safeguards to prevent personal injury or damage to equipment in the event of such failure.

System designers must provide a warning to end users in the system instructional manual if protection against a failure mode cannot be adequately provided.

System designers and end users are cautioned to review specific warnings found in instruction sheets packed and shipped with these products.